

SUPERMARKET G3 – ALUMINIUM SYSTEM ALUMINIUM RAIL SYSTEM

G3 SW 41
Supermarket
G3 – Steel Structure

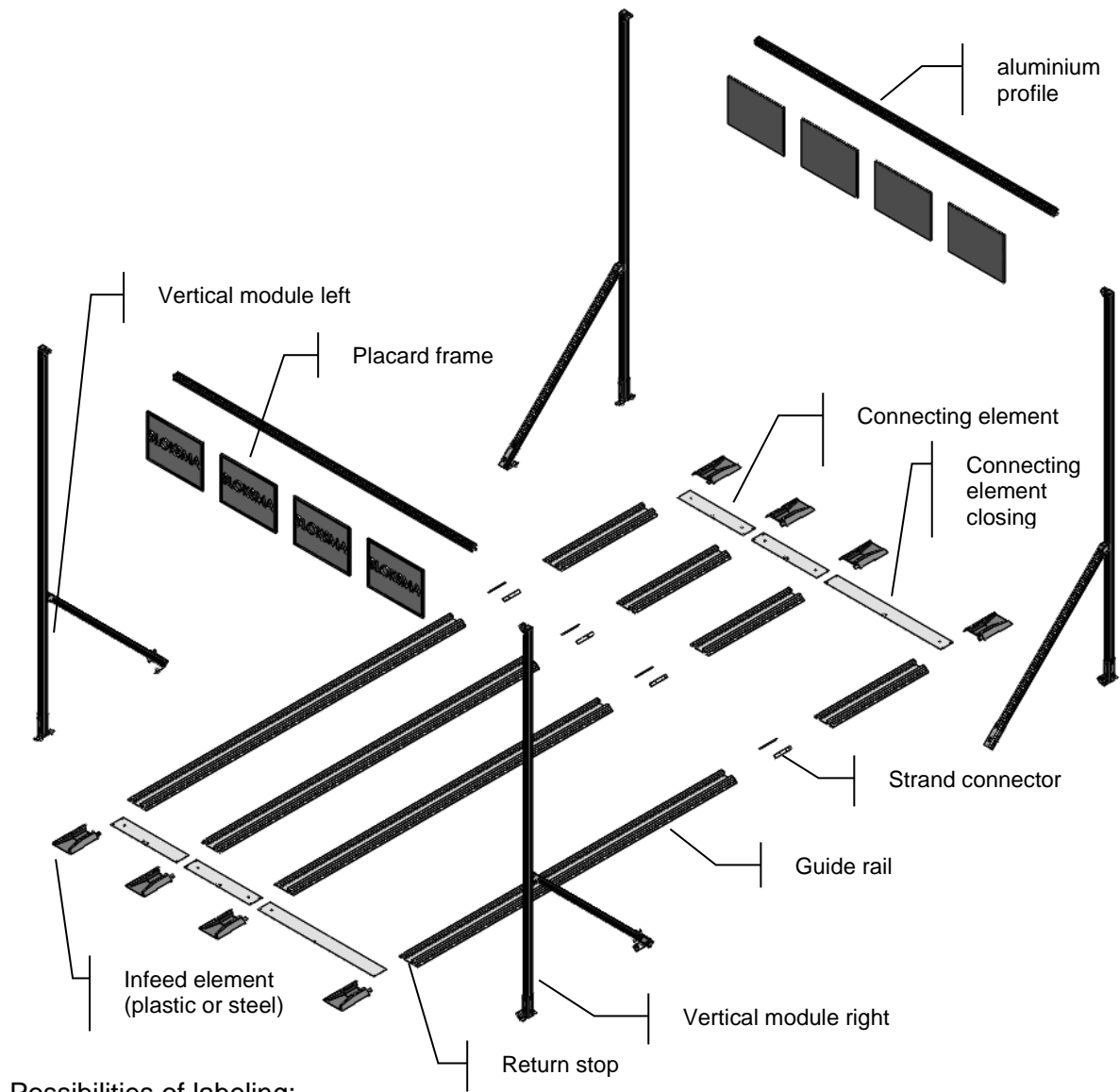

Possibilities of labeling:

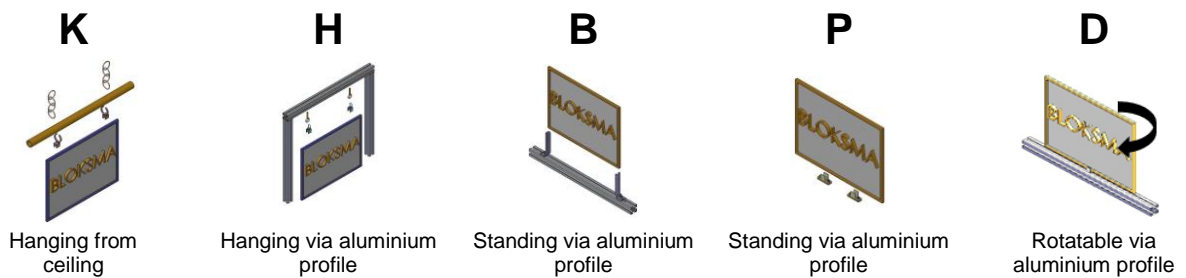

SUPERMARKET ALU GUIDE RAIL SYSTEM G3 Track 41 mm

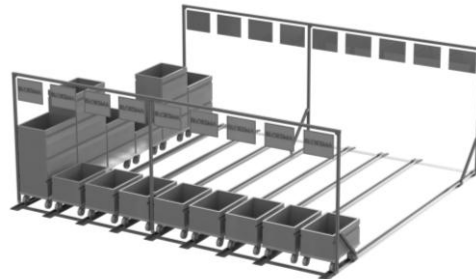
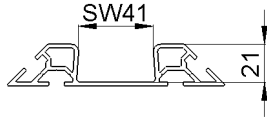

Supermarket

G3 – SW 41 – Aluminium

For trolleys with wheel width
40 mm maximum

Modular system

Single components Infeed elements

Item no.	Description	Model
138124-9005	infeed element plastic FIFO-Alu-guide rail black similar RAL 9005	EBA – EFEOD
138124-1021	infeed element plastic FIFO-Alu-guide rail yellow similar RAL 1021	EBA – EFEOD
138124-3001	infeed element plastic FIFO-Alu-guide rail red similar RAL 3001	EBA – EFEOD
205600	infeed element steel FIFO-Alu-guide rail steel – galv. zinc-coated, solide	EBA – EFEOD



Guide rails Encryption

Item no.	Length	Processing
138318-xxxxx		
	Please fill in the required length in mm of the rail	A = anodized E = yellow similar RAL 1021
132917-xxxxx	cover profile for guide rail 8 mm groove	

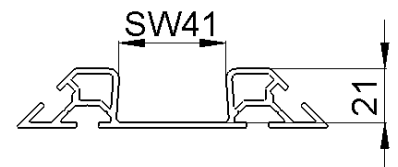
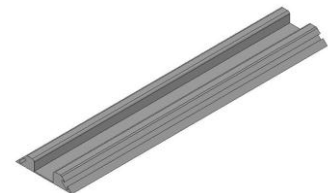

Example: **138318-0800A** Aluminium guide rail with the length 800 mm, anodized

SUPERMARKET ALU GUIDE RAIL SYSTEM G3

Track 41 mm

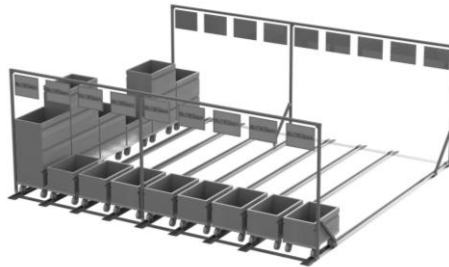
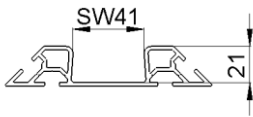

Supermarket

G3 – SW 41 – Aluminium

For trolleys with wheel width 40 mm maximum

Modular system

Single components

Connecting elements – stoppers

Item no.	Description	Remark/trolley
201500-0396	connecting element inserted lengthwise	trolley 600 x 400 mm model BOF
201500-0714	connecting element - closing inserted lengthwise	trolley 600 x 400 mm model BOF
201500-0596	connecting element inserted crosswise	trolley 600 x 400 mm model BOF
201500-0996	connecting element - closing inserted crosswise	trolley 600 x 400 mm model BOF
201500-0796	connecting element inserted crosswise	trolley 800 x 600 mm model BOF
201500-1514	connecting element - closing inserted crosswise	trolley 800 x 600 mm model BOF
201500-0460	connecting element inserted crosswise	trolley 630 x 430 mm model BOZ
201500-0785	connecting element - closing inserted crosswise	trolley 630 x 430 mm model BOZ
201500-0646	connecting element inserted crosswise	trolley 630 x 430 mm model BOZ
201500-1156	connecting element - closing inserted crosswise	trolley 630 x 430 mm model BOZ

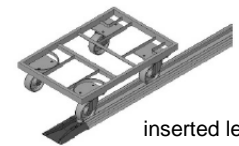
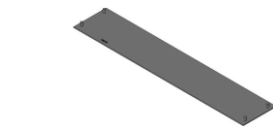
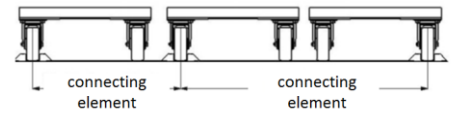

return stop

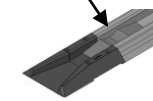

shackles

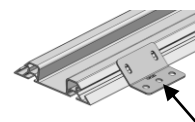

connecting element

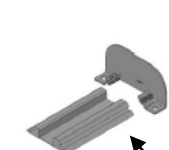

brake – brush

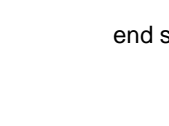

end stop rail

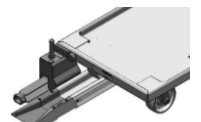

Item no.	Description	Model
141427-0040A	return stop 10 mm	EBA – RSEOD
144417-0040A	return stop 6 mm	EBA – RSEOD
142327	shackles	BBA – LADÜD
138759	connecting element guide rail	BBA – LASCD

Item no.	Description	Model
142073	end stop rail	BBA – ABRLD
139621	brake – brush – can be retrofitted	EBA – BREAD
202219-LI	ZB-stopper left	BBA – STOP3
202219-RE	ZB-stopper right	stopper BBA – STOP3

SUPERMARKET ALU GUIDE RAIL SYSTEM G3

Track 41 mm

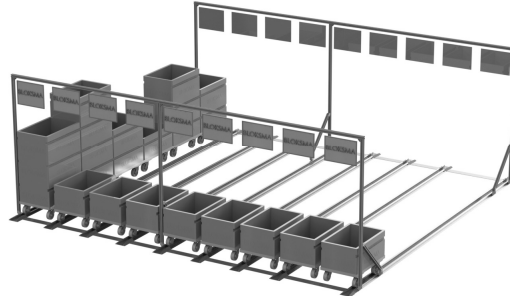
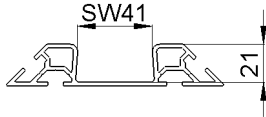

Supermarket

G3 – SW 41 – Aluminium

For trolleys with wheel width 40 mm maximum

Modular system

Single components for labeling

Vertical modules

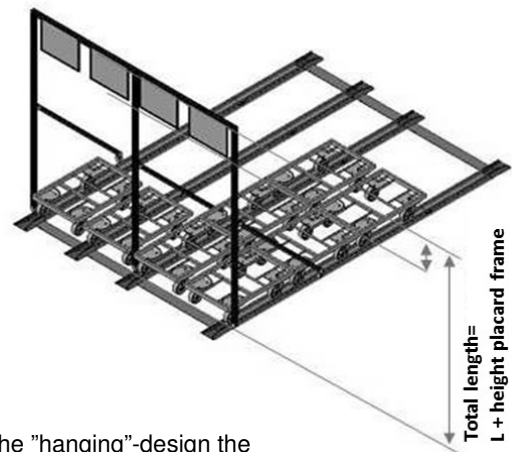
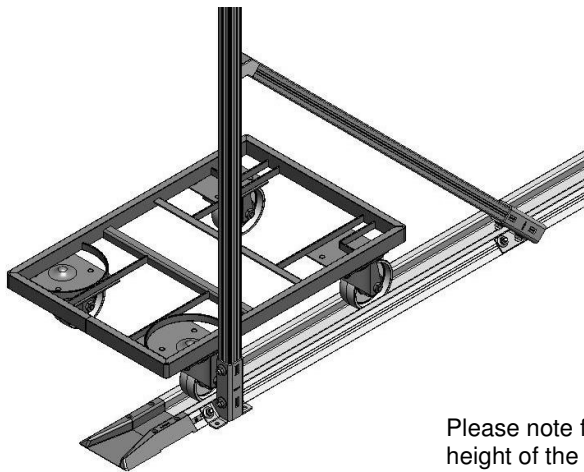

Please note for the "hanging"-design the height of the placard frame. "total length" = clearance requested plus height of placard frame

202216-L	_____	vertical module left for trolley 600 x 400 mm BOF	size A 41 mm
202216-R	_____	vertical module right for trolley 600 x 400 mm BOF	size A 41 mm
202247-L	_____	vertical module left for trolley 600 x 400 mm BOZ	size A 52.5 mm
202247-R	_____	vertical module right for trolley 600 x 400 mm BOZ	size A 52.5 mm
Please fill in the requested length in mm. ↑			

Example: 202216-L2100

Vertical module left, height 2.100 mm

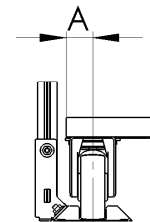

Please contact us if your trolley size A is not listed so that we can design and offer your appropriate vertical module

SUPERMARKET ALU GUIDE RAIL SYSTEM G3

Track 41 mm

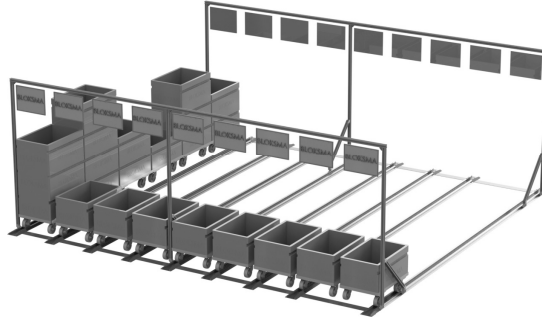
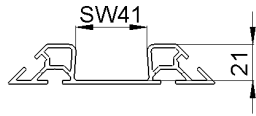

Supermarket

G3 – SW 41 – Aluminium

For trolleys with wheel width 40 mm maximum

Modular system

Single components for labeling Vertical modules and aluminium profiles

Item no.	Description	Model	Compatible with following trolleys
202237-V	profile holder front	BBA – PRHD	trolley 600 x 400 mm model BOF
202237-L	profile holder left	BBA – PRHD	trolley 600 x 400 mm model BOF
202237-R	profile holder right	BBA – PRHD	trolley 600 x 400 mm model BOF
202236-V	profile holder in front	BBA – PRHD	trolley 600 x 400 mm model BOZ
202236-L	profile holder left	BBA – PRHD	trolley 600 x 400 mm model BOZ
202236-R	profile holder right	BBA – PRHD	trolley 600 x 400 mm model BOZ

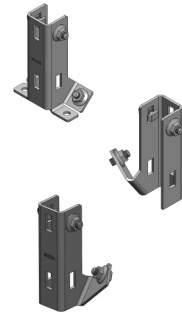

202217	profile holder circular tube	BBA – PRHD
--------	------------------------------	------------

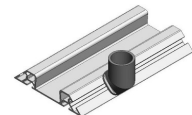

Item no.	Description	Length	Processing
132401	aluminium profile 30 x 30 mm labeling from ceiling or with vertical modules possible	↑ ↑ ↑ ↑	A
132404	aluminium profile Ø 28 mm labeling from ceiling	↑ ↑ ↑ ↑	A
142419	aluminium profile round Ecoshape labeling from ceiling with vertical modules possible	↑ ↑ ↑ ↑	A
Please fill in the requested length in mm.			A = anodized



Example: **142419-0800A** Aluminium profile round with grooves, length 800 mm, anodized